

TRUCK TYRE CHANGERS accessories

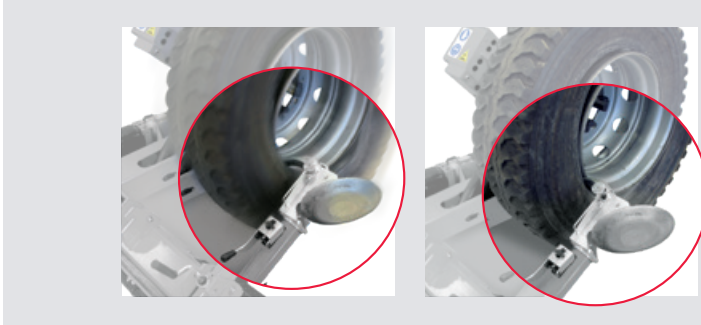

Bead press

G108A34
Premi tallone pneumatico
Pneumatic bead pushing device
Pneumatischer Wulstdrücker
Pousse-talon pneumatique
Prensa talón neumático



Leverless kit

G108A27 - G108A26 - G108A37 - G108A33
Kit per uso con leva o senza leva.
Kit for lever or leverless usage.
Mit oder Ohne Montierhebel Satz.
Kit pour fonctionnement avec ou sans levier.
Kit para empleo con o sin palanca.

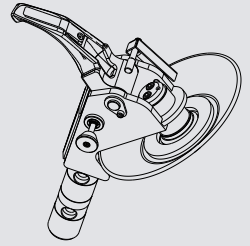

Protezioni - Protections - Alufelgenschutz Protections - Protecciones



G108A1
G108A2
Kit protezioni per cerchi in lega (n°4 pezzi).
4 clamp protections for alloy rims.
Satz Alufelgenschutz (4 Stk).
Kit de protection (n°4) pour jantes en alliage.
Protección garras (n°4) para llantas de aleación.

Adattatori - Claws adapter - Adapter - Adaptateurs - Adaptadores



G108A39
Serie prolunghe presa mandrino.
Set of extensions to increase clamping capacity.
Verlängerungen.
Kit rallonges prise mandrin.
Juego extensiones agarre plato.

G90A2 - G96A2 - G108A36
Rullo per tubeless.
Tubeless roller.
Abdrückrolle für schlauchlose Reifen.
Rouleau pour tubeless.
Rodillo para tubeless.

G108A8
Kit anelli plastificati.
Plastified rings kit.
Satz Plastikringe.
Kit anneaux plastifiés.
Juegos anillos plastificados.



G108A5
Adattatori ad aderenza maggiorata.
Adapters with increased adherence.
Adapter.
Adaptateurs adhérence majeure.
Adaptadores con adherencia suplementar.

Dispositivi vari - Various - Verschiedenes - Divers- Varios



G90A6
Morsetto bloccatallone per cerchi in lega.
Bead-locking clamp for alloy rims.
Wulstklemme für Leichtmetallfelgen.
Mors bloque-talon pour jantes en alliage.
Mordaza de bloqueo talón para llantas de aleación.



G108A25
Morsetti bloccatallone ruote movimento terra.
Bead locking clamp for earth moving wheels.
Satz Klemme für EM-Felgen alle Modelle.
Mors bloque-talon des pneus des engins de terrassement.
Mordazas de bloqueo talón ruedas tractores



G108A16
Pennello.
Brush.
Montagepinsel.
Pinceau.
Brocha profesional.



G800A37 (3,5 kg / 8 lb)
Pasta di montaggio.
Mounting grease.
Montagepaste.
Pâte de montage.
Jabón profesional

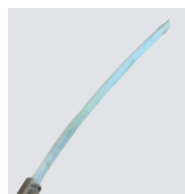

G108A3
Leva con testina.
Lever with tool.
Montierhebel.
Levier.
Palanca



G108A13
Leva per cerchietti.
Rings lever.
Montierhebel.
Levier pour bagues.
Palanca para anillos.

VASCHE A CALDO / WASHING TANKS WITH HEATED WATER / HEISSWASSER TEILE WASCHMASCHINE / BACS DE LAVAGE A EAU CHAUDE / LAVADORAS DE PIEZAS DE AGUA CALIENTE



VE 1200M
 • Ø = 1200 mm
 • 220 litres

Motor Rotation



CAVALLETTI MOTORE / ENGINE STANDS / MOTORBÖCKE / SUPPORT MOTEURS / SUPORTES PARA MOTORES



R10
 • 500 kg



R12
 • 800 kg



R11
 • 1.200 kg

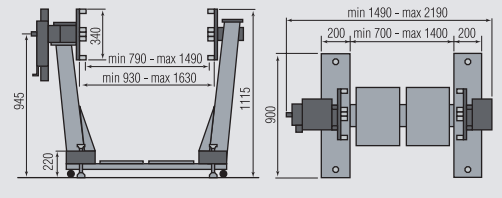
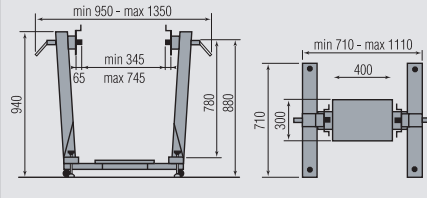
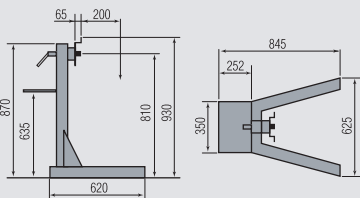

BANCO ROTATIVO / ROTATING ENGINE STAND / ROTATION STAND / SUPPORT ROTATIF / BANCO ROTATIVO PARA MOTORES

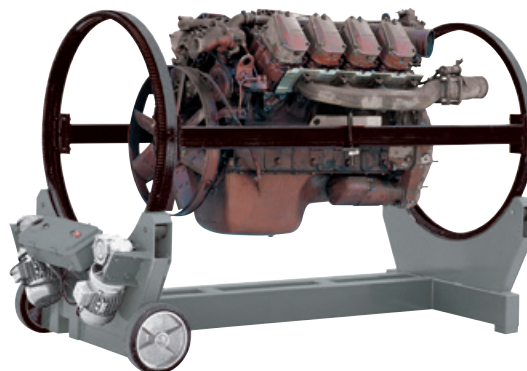
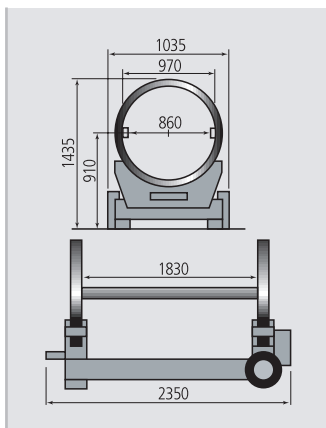

R15
 • 2.000 kg
 • 2x0,5 kW
 • 1 rpm

